

- | | | | | | |
|------------------|------------------|----------|-----------|----------|-------------------|
| 1
8x36
x22 | 2
x1 | 3
x2 | 4
x1 | 5
x4 | 6
3,5x16
x8 |
| 7
x1 | 8
3x16
x15 | 9
x2 | 10
x60 | 11
x2 | 12
x30 |
| 13
x22 | 14
4x20
x8 | 15
x4 | | | |
| 16
x1 | | | | | |

Czas mont. - 60 min.

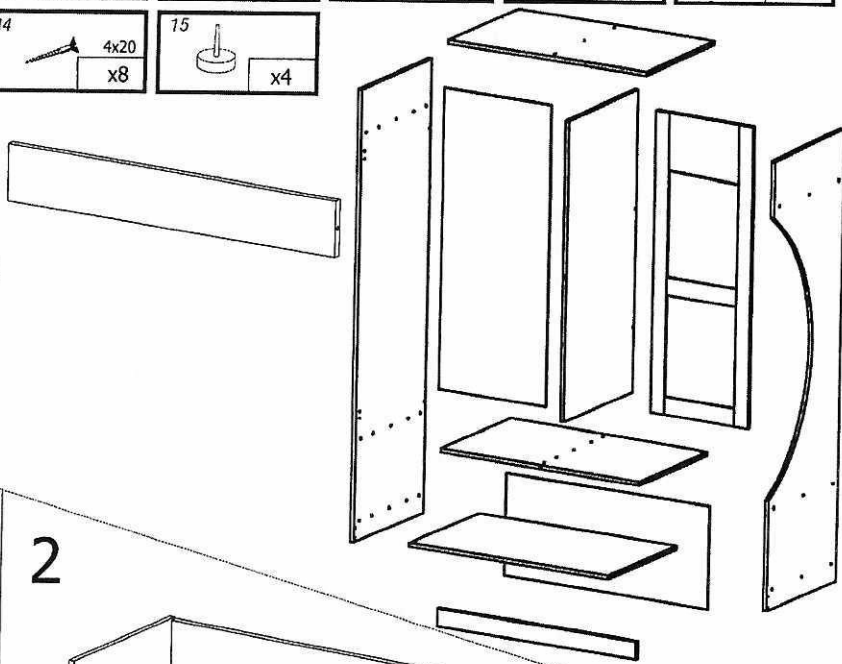

1

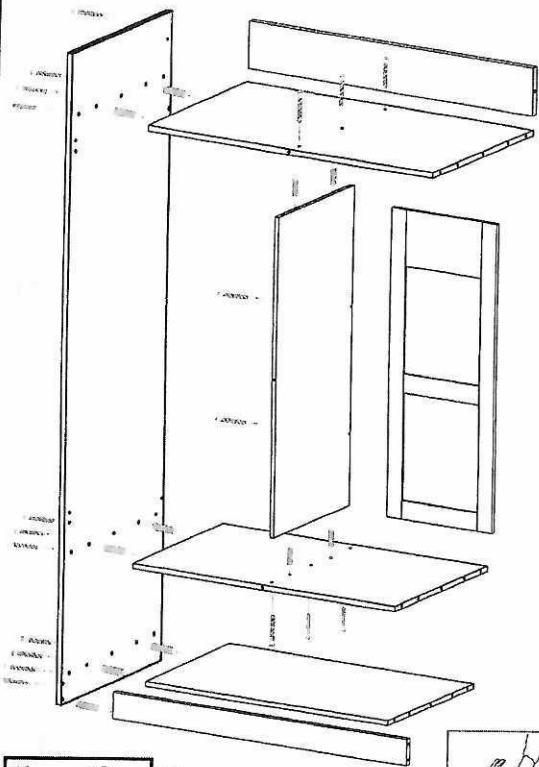

2

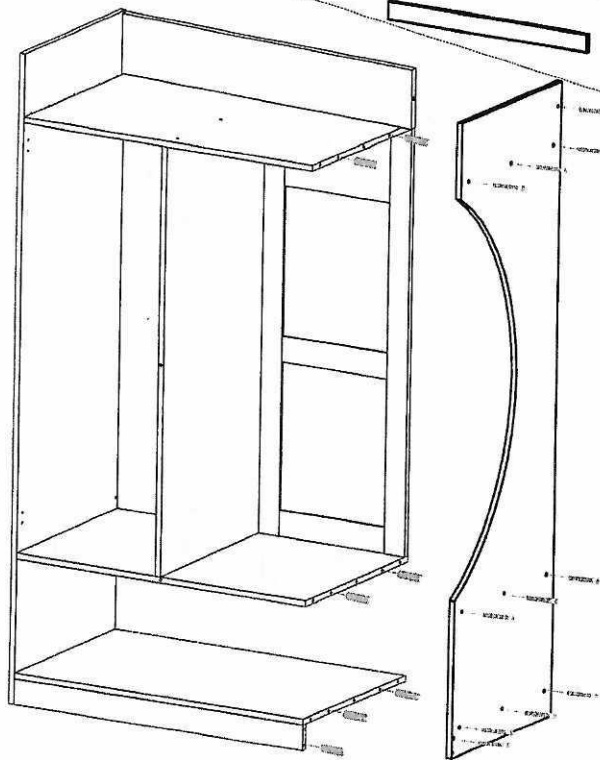

- | | |
|-----------|--|
| 12
x19 | |
|-----------|--|



- | |
|-----|
| x11 |
|-----|

- | |
|----|
| x7 |
|----|

- | |
|-----------|
| 12
x11 |
|-----------|



3

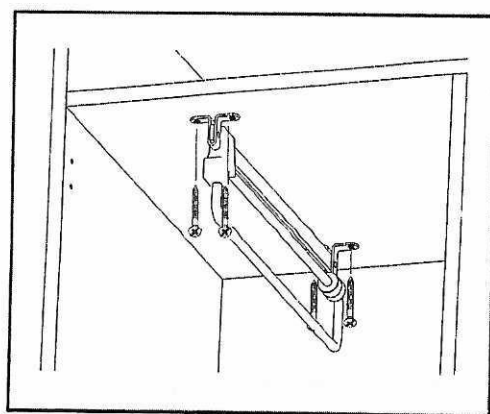

- | |
|----------|
| 16
x1 |
|----------|

- | |
|-----------------|
| 8
3x45
x4 |
|-----------------|

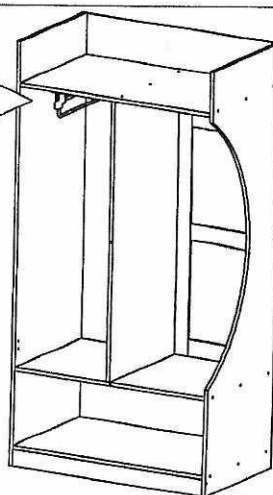

4

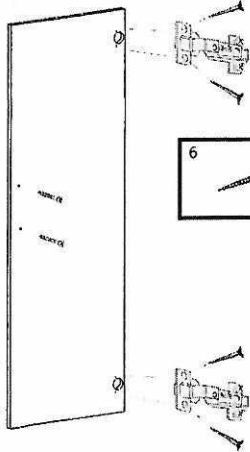
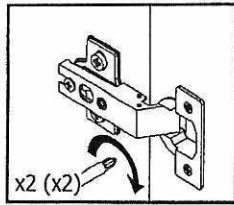
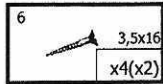
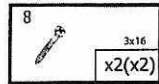
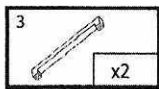

5

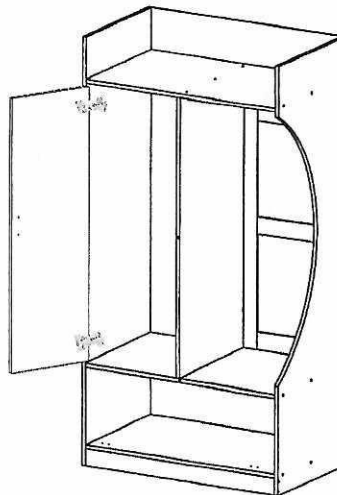
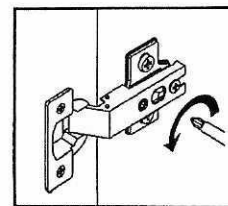

6

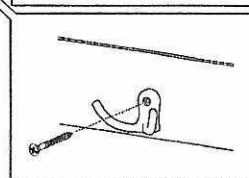
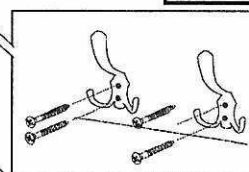
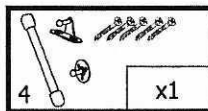
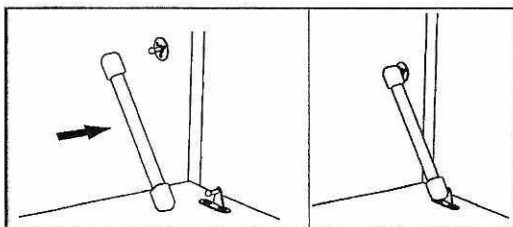
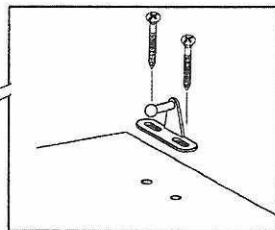
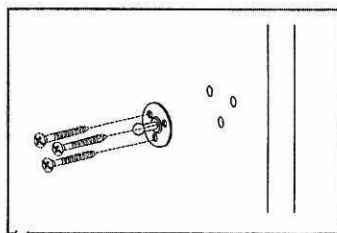
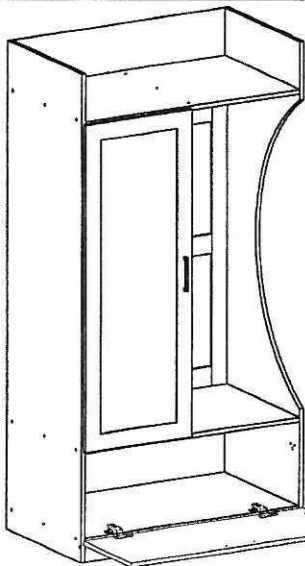

7

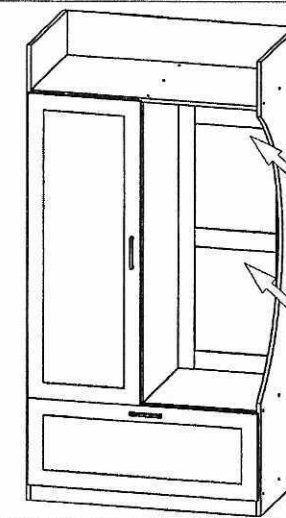

8

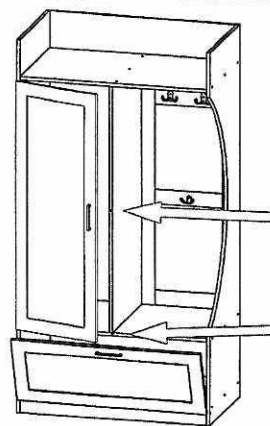
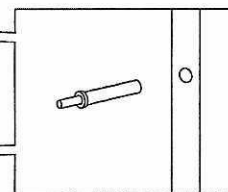
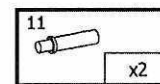

9

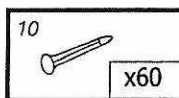
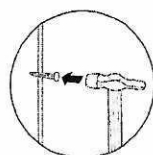
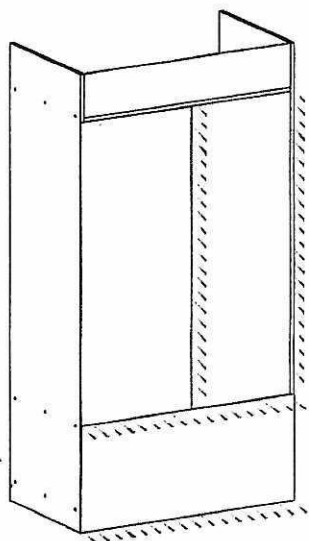
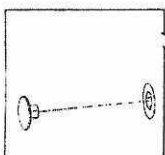
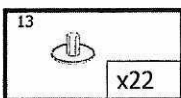

10

